

Block 2.0

Linea di pattumiere di Grande e Grandissima capacità per raccolta differenziata.

Sistema completo ed estremamente robusto realizzato con componenti in lamiera di acciaio zincato verniciato a polveri epossidiche e plastiche in Nylon caricato in fibra di vetro, viene fornito con guide Hettich ad estrazione totale con soft-closing. Il sistema ottimizza al massimo lo spazio disponibile sia per soluzioni di grandissima capacità in basi della cucina dedicate, sia in soluzioni in profondità ridotta idoneo anche per esser inserito in basi con lavello. Progettato per un'installazione semplice e veloce, ha un sistema di regolazione dell'anta in 3D pratico che garantisce la massima precisione. La sede di alloggio dei contenitori è caratterizzata da un profilo imbutito che oltre ad irrobustire la struttura la rende anche più gradevole. Il ripiano in metallo è un optional utile come coperchio fisso o ripiano porta oggetti. Disponibile per basi di larghezza 300mm, 400mm, 450mm, 500mm e 600mm ed in profondità 350mm, 420mm e 470mm; sia nelle versione da collegate direttamente all'anta, sia con maniglia per un'apertura manuale.

Caratteristiche:

1. Struttura in lamiera di acciaio zincato verniciato a polveri epossidiche realizzata in un monoblocco.
2. Fissaggio laterale e frontale in Nylon caricato con fibra di vetro dotato di guide Hettich V6 ad estrazione totale e soft closing.
3. Alloggi dei contenitori realizzati con profilo imbutito.
4. Contenitori da 12 a 35 litri (capacità complessiva fino a 86 litri).
5. Disponibile in 5 larghezze e 3 profondità.
6. Compatibile con fianchi da 16, 18 e 19 mm.
7. Può esser collegata direttamente all'anta oppure montato all'interno di una base con anta incernierata.
8. L'optional svolge la funzione di ripiano porta oggetti o coperchio fisso.
9. Facile da installare e da pulire.
10. Regolazione in 3D dell'anta. Regolazione in 3D dell'anta.

Large and Very Large Capacity bins range for separate waste collection. Extremely solid structure made out of components in Epoxy powder painted galvanized steel and Fiberglass connectors equipped with Hettich full extension soft-closing runners. The system maximizes the available space both for very large capacity solutions in standard kitchen bases and in lower depth cabinets. Block 2.0 is also suitable for under sink bases. Designed for quick and easy installation, it has a practical 3D door adjustment system that guarantees maximum precision. The housing space for the bins is characterized by a deep-drawn profile that strengthens the structure and makes it more attractive. The metal shelf (optional) can be used as a fixed lid or eventually as a simple rack for any object. Available for base widths of 300mm, 400mm, 450mm, 500mm and 600mm and depth 350mm, 420mm and 470mm; in the front door fixing version or for hinged doors cabinets with manual extraction.

Features:

1. Single block structure manufactured in Epoxy powder painted steel sheet.
2. Fiberglass reinforced Nylon supports equipped with Hettich V6 total extraction and soft closing runners.
3. Deep-drawn profile for containers housing.
4. Bins from 12 to 35 to 86 liters (total capacity up to 86 liters).
5. Available in 5 widths and 3 depths.
6. Compatible to 16, 18 and 19 mm panel thickness.
7. To be fixed directly to the front door or installed inside a cabinet base with hinged door.
8. The accessory acts as a shelf for objects or as a fixed cover.
9. Easy assembling and cleaning.
10. 3D adjustment of the door.

Línea de contenedores de grande y muy grande capacidad para la recogida selectiva de residuos.

Sistema completo y extremadamente robusto hecho de componentes de chapa de acero galvanizado recubierto de polvo epoxídico y plástico de nylon reforzado con fibra de vidrio, suministrado con guías con extracción total y amortiguación integrada de Hettich. El sistema optimiza al máximo el espacio disponible, tanto para soluciones de gran capacidad en armarios de cocina específicos como en soluciones de profundidad reducida también adecuadas para su inserción en armarios con fregadero. Diseñado para una instalación rápida y fácil, tiene un práctico sistema de ajuste de la puerta en 3D que garantiza la máxima precisión. El alojamiento de los contenedores se caracteriza por un perfil canalizado que no sólo refuerza la estructura, sino que también la hace más agradable. El estante de metal es una opción útil como tapa fija o estante para objetos. Disponible para bases de 300mm, 400mm, 450mm, 500mm y 600mm de ancho y 350mm, 420mm y 470mm de profundidad; ambas en la versión para ser conectadas directamente a la puerta y con manija para apertura manual.

Caratteristiche:

1. Estructura en chapa de acero galvanizado recubierta de polvo epoxídico, hecha en un monobloque.
2. Fijación de los lados y de la fuente en nylon reforzado de fibra de vidrio con guías de Hettich V6 con extracción total y amortiguación integrada.
3. Estructura metálica de los contenedores realizada con perfil canalizado
4. Contenedores de 12 a 35 litros (capacidad total de hasta 86 litros).
5. Disponible en 5 anchos y 3 profundidades.
6. Compatible con paneles de 16, 18 y 19 mm.
7. Puede conectarse directamente a la puerta o montarse dentro de una base con puerta abatible.
8. El extra opcional actúa como un estante para objetos o una tapa fija.
9. Fácil de instalar y limpiar.
10. Ajuste de la puerta en 3D. Ajuste de la puerta en 3D.





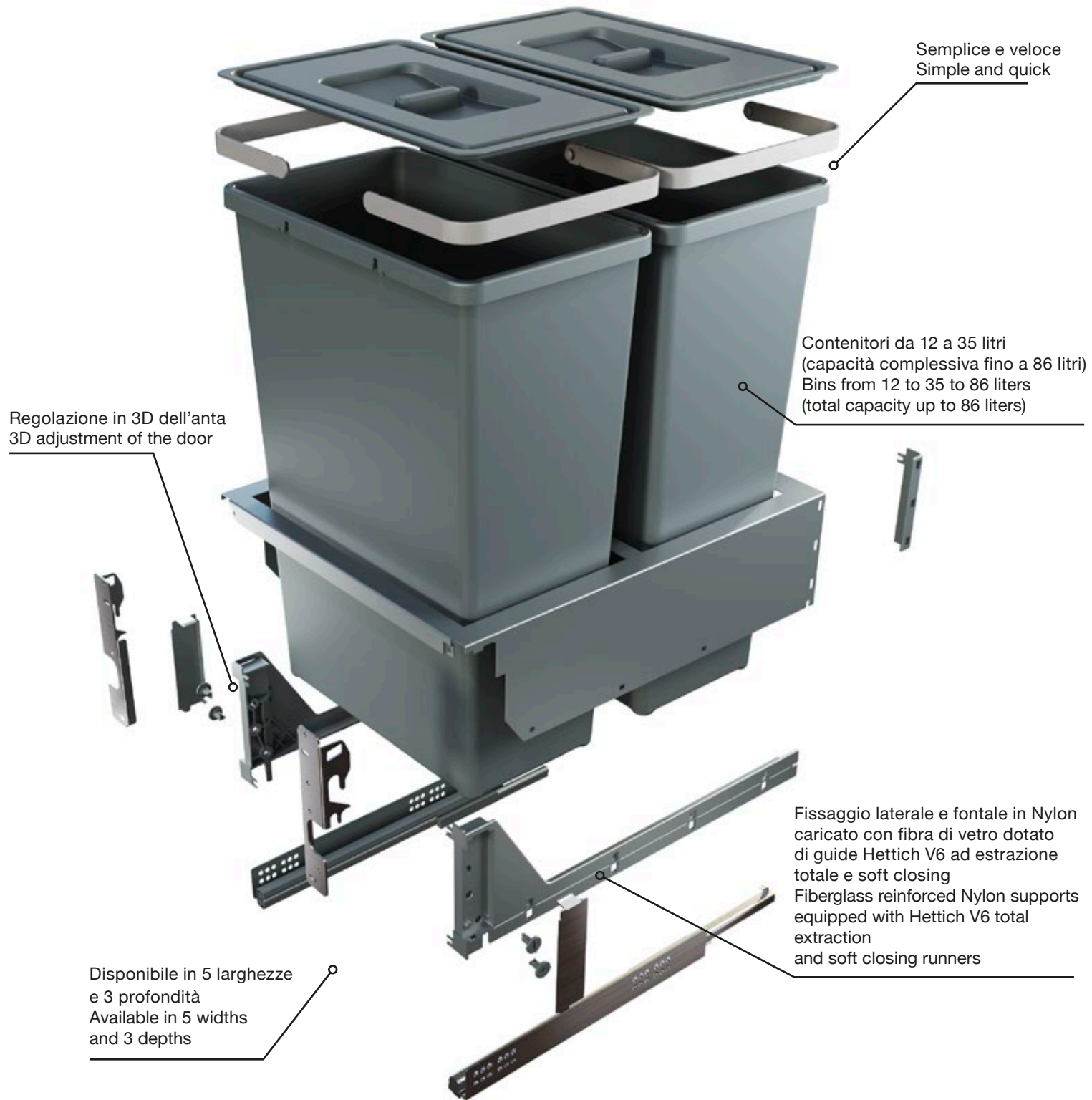

Block 2.0



Colore 
Colors



Finitura Lamiera Verniciata
Finish Varnished sheet metal

Dimensioni Disponibile per tutte le larghezze e
Dimensions profondità offerte
Available for all offered widths and
depths

Coperchio opzionale per articoli:

PBR A4230A
PBR A4245A
PBR A4250A
PBR A4260A
PBR A4730A
PBR A4740A
PBR A4745A
PBR A4750A
PBR A4760A



PBR ----

PBR A4230A

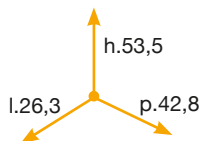

35



kg 5

Av



1



60x42x28



28



84x120x238

30



PBR A4245A

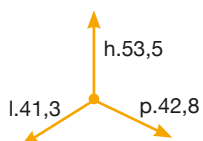

35

12



kg 5

Av



1



60x42x28



28



84x120x238

45



PBR A4250A

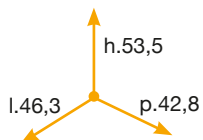

35

12



kg 6

Av



1



60x62x28



20



100X125X224

50



PBR A4260A

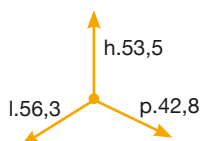

35

35



kg 6

Av



1



60x62x28



20





100X125X224

60





PROFONDITA' 470 mm./ Depth. 470 mm.

 C97

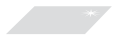
 5

 Av

 1

 60x42x28

 28

 84X120X238

 30

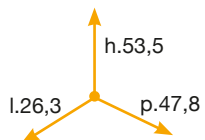

35





PBR A4730A

 C97

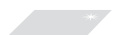
 5

 Av

 1

 53X44X45

 24

 80X120X231

 40

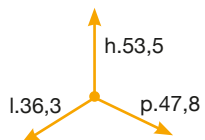

35





PBR A4740A

 C97

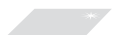
 5

 Av

 1

 60X42X28

 28

 84X120X238

 45

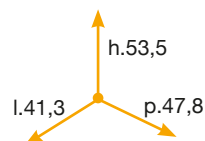



35 35





PBR A4745A

 C97

 6

 Av

 1

 60X62X28

 20

 100X125X224

 50

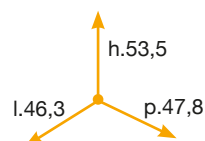

35 35





PBR A4750A

 C97

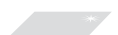
 6

 Av

 1

 60X62X28

 20

 100X125X224

 60

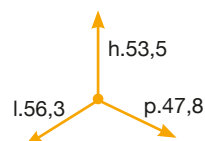

35 35 8 8



PBR A4760A